

AIO

BKS

Assembly kit post

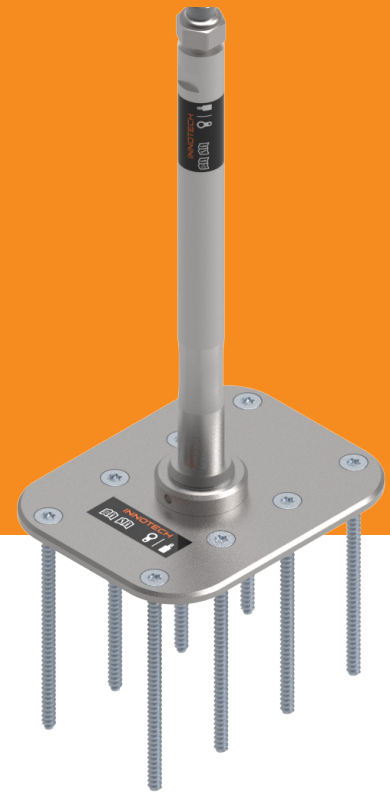

Using the BKS assembly kit post from INNOTECH, only a stop shaft is required for securing all further components in the horizontal lifeline system. The economical BKS assembly kit post is made up of two components, and is used in the lifeline

system as a single anchor point or as an end, corner, and intermediate post. In addition, it can also be used together with INNOTECH UNI-EAP-10-25 as a single anchor point.

- Installation can be performed in two steps
- Post spacings up to 12m are possible in the lifeline system
- Can also be used with INNOTECH UNI-EAP-10-25 as a single anchor point
- Mechanical anti-rotation device ensures a secure hold

- High level of prefabrication, especially for timber construction
- Very easy to install, no special tools required
- Certification to the latest state of the art:

EN 795:2012 TYPES A and C
CEN/TS 16415:2013

Assembly kit post

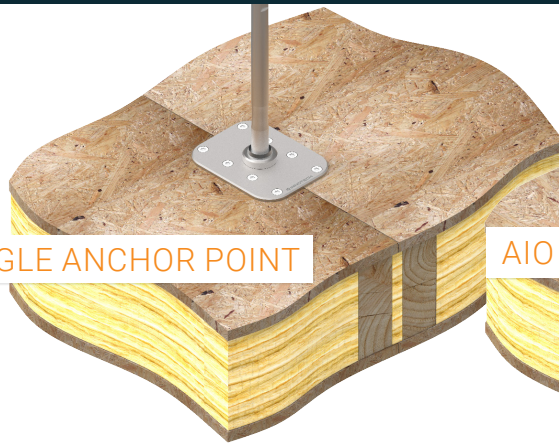

EAP | SINGLE ANCHOR POINT

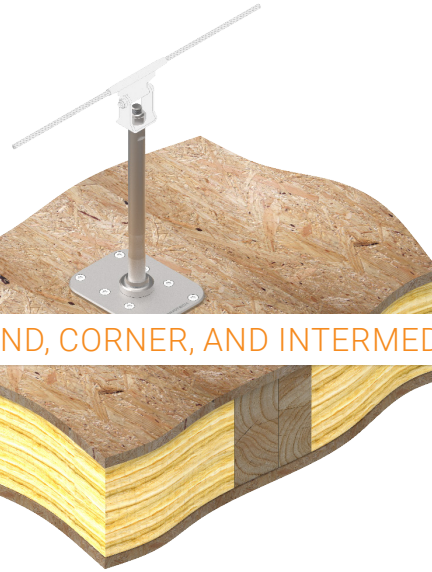

AIO | END, CORNER, AND INTERMEDIATE POST

BKS | BASE PLATE

BKS-GP-01

BASE PLATE FOR END, CORNER, AND INTERMEDIATE POST IN THE AIO LIFELINE SYSTEM FOR LIGHTWEIGHT WOODEN CONSTRUCTION (EN 795 C)

Substructure: wood at least 14 x 16 cm
Roofing elements made of wood
(Requirements as per product description)
Material: stainless steel (AISI 304)
Base plate dimensions: 178 x 140 x 40mm

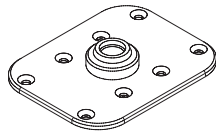

BKS | STOP SHAFT

BKS-AW-01

STOP SHAFT FOR END, CORNER, AND INTERMEDIATE POST IN THE AIO LIFELINE SYSTEM FOR LIGHTWEIGHT WOODEN CONSTRUCTION (EN 795 C)

Substructure: base plate BKS-GP-01
Material: stainless steel (AISI 304)
Length: 300 mm

Optional use as a single anchor point in conjunction with UNI-EAP-10-25 possible!

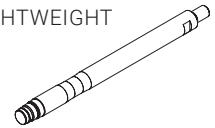

STANDARD SOLUTION

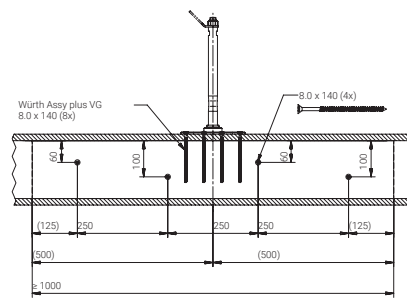
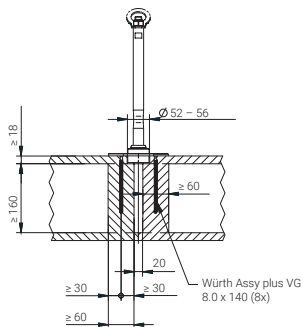

BEAM SUPPORTING OPTIONS

